



The Winning Force

**DURMA**

# AD-S SERIES PRESS BRAKES



- Perfect Precision
- Deep And Fast Bending
- Efficient
- Winning
- Elegant Design





# **DURMA** The Winning Force





As a total supplier for sheet metal manufacturing with almost 60 years of experience, Durma understands and recognizes the challenges, requirements and expectations of the industry. We strive to satisfy the ever higher demands of our customers by continuously improving our products and processes while researching and implementing the latest technologies.

In our three production plants with a total of 150.000 m<sup>2</sup>, we dedicate 1,000 employees to delivering high quality manufacturing solutions at the best performance-to-price ratio in the market.

From the innovations developed at our Research & Development Center to the technical support given by our worldwide distributors, we all have one common mission: to be your preferred partner.

Present Durmazlar machines with **DURMA** name to the world.



1  
High technology,  
modern production  
lines



2  
Top quality  
components

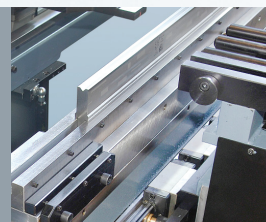

3  
High quality  
machines designed  
in R&D Centre

DURMA



# The Winning Force

## Feel The Force and Performance

Our Machines are shaped with our superior experience and state of art technology, special designed as well as excellent combined component its the fastest , most reliable and prices press brakes on its category.

With its rigid body structure, robust back gauge and high standard components it ensures long lasting and precision applications.

Therefore with *DURMA* press brakes you can always achieve perfect result.





# Fast, Precise and Perfect Bending

Precise bending result at fast speed

Minimalized tool change and adjustment time

Maximized speed and safety



# AD-S Series Press Brake



# Perfect and Fast Bending

## Perfect components for precision

With Easy to use control unit, stabile body structure, perfect design, low operating cost, different tool usage options, maximum safety standards, DURMA press brake is the best in the world in its segment.



High Capacity

Robust Body

Perfect Precision

Winning

Ergonomic

## Why *DURMA* Press Brakes

- Better and faster bending
- Stronger and rigid body structure
- High sensitivity and repeatability
- High technology excellent equipment
- Low service cost
- Reliability

# Fast, Efficient, Modern

AD-S Series press brakes, designed with high technology to increase efficiency on precise part bending.

Quality approved components.  
Stress relieved for long life and precise bending.



## General Specifications

- High sensitivity, Stress relieved steel construction body, long life Mono Block Frame
- Automatic calibration and first start up
- DURMA designed and copyrighted guiding system
- Ball Screw and linear guide integrated perfect back gauge system
- Durable, long life and sensitive bending capable special hardened top tools
- Suitable for segmented tools special and fast tool holding system
- Sensitive solutions on Long and deep bending
- High accuracy linear scales
- CE safety standards
- Best quality world wide accepted hydraulic and electric components





# Strong Back Gauge Systems

- Precise
- Reliable
- Strong

- Fast and high accuracy
- Safe movement
- Resistance to crash
- Maintenance free
- Adjustment availability at every point

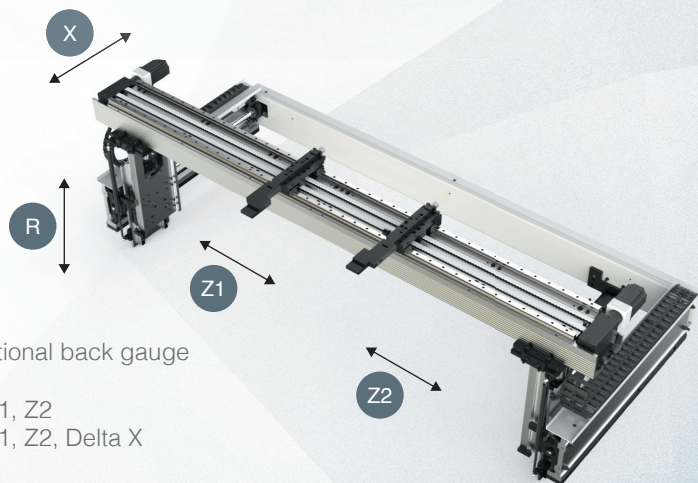

## Why *DURMA* Back Gauge ?

The most important feature to achieve perfect bending is the stability and the design of the back gauge, which allows an impeccable and correct product to be produced.

The high speed **ballscrew** back gauge system movement is also supported with **linear guides**, which helps the back gauge achieve long life, greater sensitivity and strengthens against any collisions.

Special designed finger blocks with steps to achieve maximum stability can also be supplied for every kind of bending solution.

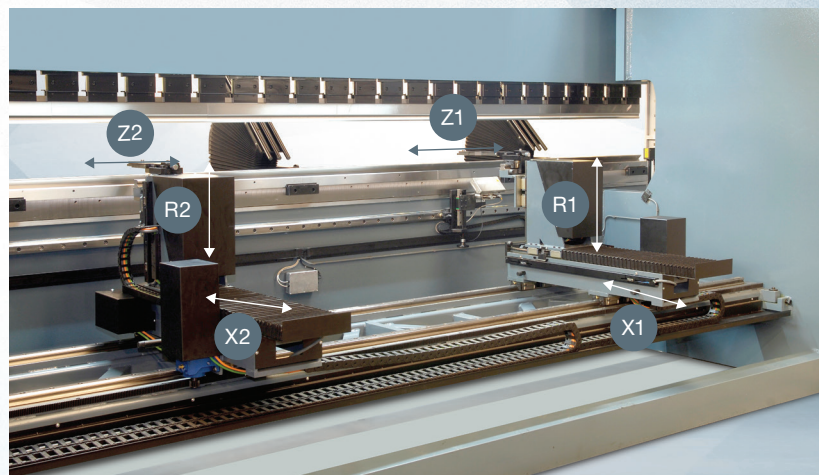



# Tool Holders and Tools

Bending performance is increased by using high quality European clamping system and easiness to use. Narrow table designed for European style tool holder and Z bending.

DURMA is your solution partner with various tool options.



European Clamping System

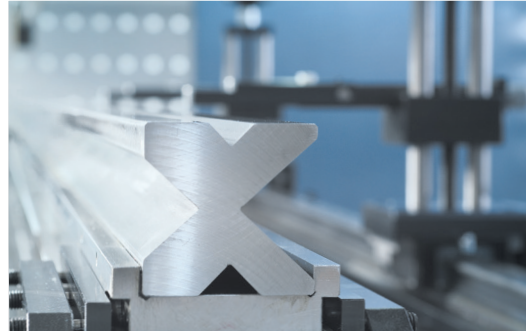

European Type Bottom Tool (4V Die)

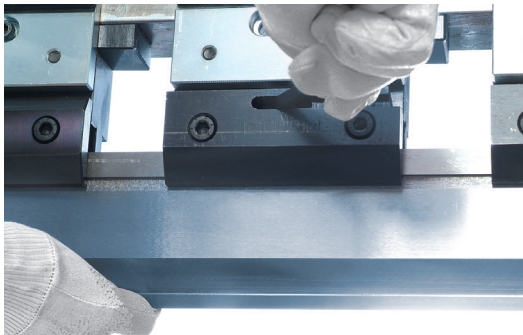

Quick Release Clamping



Wila Bottom Tool Clamping



Wila Top Tool Clamping

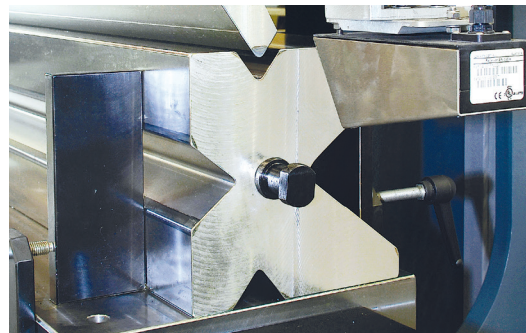

DURMA Bottom Tool Multi V



DURMA Top Tool

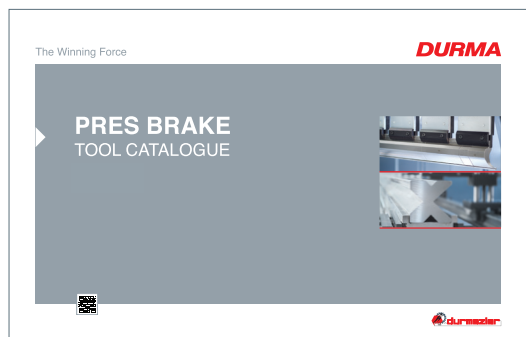



# Safe and Accurate Bends with Top Quality Equipments

## Crowning System

Manual or CNC-controlled motorized crowning system simplifies bending by adjusting each point of the bending parts to acquire straight bends. The need for shimming is eliminated.



## Linear Guide Front Sheet Supports

Rugged support arms with tilting stops are mounted on a linear guide rail system. This allows "finger-tip" lateral adjustment as required by the bend length of the part. They are also equipped with side gauges for the fast, easy, and accurate feeding of parts small or large.



Linear Guide Front Sheet Supports

## CE Safety Systems

Our machines are designed in accordance with Ce-Norms to ensure your safety with hydraulic, electric, appropriate height covers and laser light curtains. CE safety in tandem machines are also provided with light barriers.



Ce Laser Safety System

## Stable Top Beam Movement

By using long and planar guiding surfaces, all the disadvantages of point guiding are eliminated 100%. Free bending space: guiding system that eliminates bending between frame has been moved to the outside of the frame.

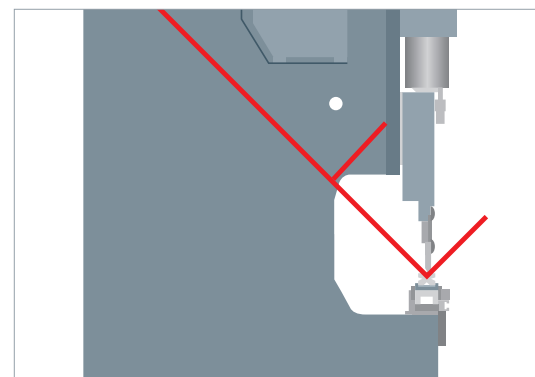

90 Degree Endless Bend

# Now Bending is More Easier

## ModEva 19T



- 19" colour Touch Screen
- On-screen finger profile drawing
- Automatic bend listing
- Very simple and convenient data transfer
- Higher productivity thanks to easy and rapid
- Multi-simulation capability
- Simulation criteria for better sheet management
- Windows XPe for multitasking and file management
- EC safety-cycle management
- Ethernet for easy communication

## DA-66T



- 2D graphical touch screen programming mode
- 3D visualisation in simulation and production
- 17" high resolution colour TFT
- Full Windows application suite
- Delem modusys compatibility
- USB, peripheral interfacing
- User specific application support within the controllers multitasking environment
- Sensor bending & correction interface
- Profile - TL - software

## Modeva RA Premium

- Full 3D simulation
- Multiple view points while working
- 3D collision detection
- Rapid solution computation
- Importing 3D models (MetaBEND, IGES)
- Automatic Tool Shape Selection
- Video-like bend simulation.
- Almost unlimited quantity of programs and sequences

## DA-69T

- Higher grade of efficiency
- 3D and 2D graphical touch screen programming mode
- 17" high resolution colour TFT
- Delem modusys compatibility
- Sensor bending correction interface
- 1 GB memory capacity
- Integrated OEM-Panel
- 1280x1024 pixels, 16-bit colour
- 3D graphics acceleration
- Profile - T - 3D software



### System of DURMA Angle Measurement

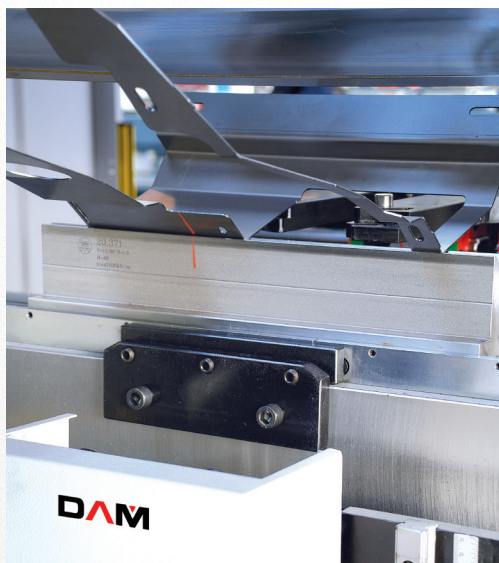

### Automatic AP3 - AP4 Sheet Follower

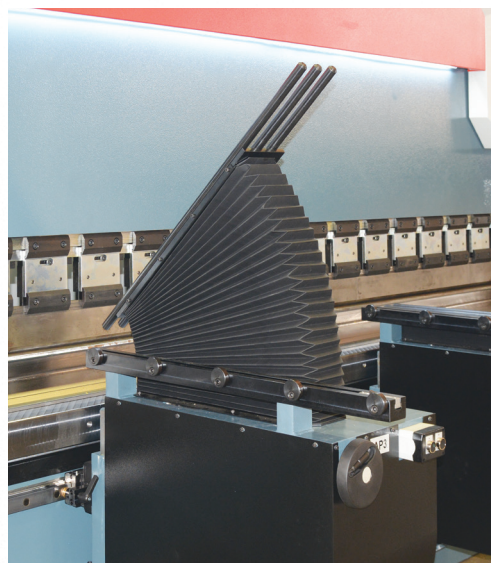

### Robotic System of Applications



# Standard & Optional Equipment

## Standard Equipment

Y1, Y2, X, R - 4- Axis  
Control Unit - CNC ModEva19T  
CE Manuel F. AKAS II M FPSC-B-C + Safety Cages with switch  
CE F.AKAS BVLTL Light barrier and safety cages (For Tandem Press Brakes)  
Servo motor back gauge & linear guided & ballscrew system (X-R)  
CNC controlled motorized Crowning  
European style tool clamping system  
Sliding front arms (With T-Slot and stopper)  
World standards special design hydraulic block and valves  
World standard electric equipment

## Optional Equipment

Control Unit - ModEva Premium, 69T ve 66T  
CE with FIESSLER AKAS-LC II AKAS - 3M Motorized + FPSC (SAFETY PLC)  
Motorized FIESSLER AKAS-3PM (distance of mute until 3)  
Z1, Z2 Axis  
X1, X2 Axis  
R1, R2 Axes  
Delta X Axis  $\pm$  125 stroke  
X Axis = 1000 mm – light barrier back protection  
AP3-AP4 Automatic system of sheet follower – Motorized elevation adjustment  
( There is a motorized elevation adjustment of 220 tons or more.)  
System of laser angle measurement  
Quick release clamping system  
Hydraulic and pneumatic tool clamping systems  
Bottom and top tools  
Bottom tool separation system  
Parking area  
Central lubrication system  
Oil cooler  
Additional back gauge finger and sliding front support arms  
Special packing for overseas shipments  
DBEND 3D bending simulation program



# Fast on Service and Spare Parts

*DURMA* provides the best level of service and spare parts with qualified personnel and spare parts in stock. Our experienced and professional service personnel are always ready at your service. Our professional training and application enriched courses will give you an advantage to use our machinery.



Consultancy



Spare Parts



R&D Center



After Sales Service



**DURMA**  
Solution Center



Service Agreements



Software



Training



Flexible Solution

# AD-S Series Technical Details

AD-S Series	Bending Force	Bending Length	Distance Between Columns	Stroke	Daylight	Throat Depth	Throat Depth	Table Width	Working Speed	
									Y Rapid Speed	Y Working Speed
									Ton	mm
	A	B	C	D	E	F	G			
AD-S 1260	60	1250	1050	265	530	450	900	104	200	10
AD-S 2060	60	2050	1700	265	530	450	900	104	200	10
AD-S 25100	100	2550	2200	265	530	450	900	104	180	10
AD-S 30100	100	3050	2600	265	530	450	900	104/180	180	10
AD-S 30135	135	3050	2600	265	530	450	900	104/180	160	10
AD-S 30175	175	3050	2600	265	530	450	900	104/240	160	10
AD-S 30220	220	3050	2600	265	530	450	900	104/240	140	10
AD-S 30320	320	3050	2600	365	630	450	900	154/300	160	10
AD-S 37175	175	3700	3100	265	530	450	900	104/240	140	10
AD-S 37220	220	3700	3100	265	530	450	900	104/240	160	10
AD-S 40175	175	4050	3600	265	530	450	900	104/240	160	10
AD-S 40220	220	4050	3600	265	530	450	900	104/240	160	10
AD-S 40320	320	4050	3600	365	630	450	900	154/300	160	10
AD-S 40400	400	4050	3400	365	630	510	1050	154/300	140	8
AD-S 40600	600	4050	3100	365	700	510	990	154/300	80	7
AD-S 60220	220	6050	5100	265	530	450	1050	154/300	140	10
AD-S 60320	320	6050	5100	365	630	450	1100	154/300	140	10
AD-S 60400	400	6050	5100	365	630	510	1220	154/300	120	8
AD-S 60600	600	6050	5100	365	700	510	990	154/300	80	7
AD-S 60800	800	6050	5100	400	700	610	800	400	70	6
AD-S 70800	800	7050	5100	400	700	610	800	400	80	7
AD-S 701000	1000	7050	5100	500	800	610	800	400	70	5
AD-S 701250	1250	7050	5100	500	800	610	900	400	70	7
AD-S 80800	800	8050	6400	400	700	610	800	400	80	7
AD-S 801000	1000	8050	6400	500	800	610	800	400	70	5
AD-S 801250	1250	8050	6400	500	800	610	900	500	70	7
AD-S 801600	1600	8100	6400	500	1000	610	900	500	70	6
AD-S 802000	2000	8100	6400	600	1000	750	950	500	70	6

Machines set according to optimum values.



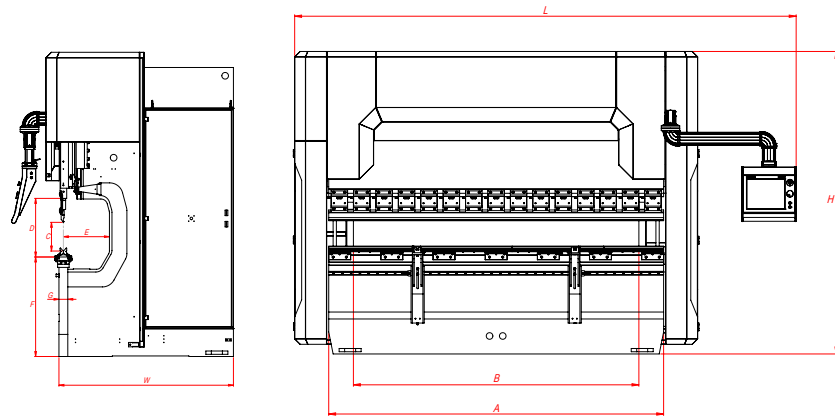

/sn.	Y Axes Precision	X Axes Working Speed	X Axes Precision	X Axes Dimensions			R Axes Working Speed	R Axes Working Distance	R Axes Precision	Z Axes Working Speed	Z Axes Working Distance	Motor Power	Oil Tank Capacity	Length	Width	Height	Weight Approx.
				650	750	1000											
0	0,01	500	0,05	S	-	O	350	250	0,1	1000	490	7,5	100	2300	1550	2850	4700
0	0,01	500	0,05	S	-	O	350	250	0,1	1000	1100	7,5	100	3200	1550	2850	5600
20	0,01	500	0,05	S	-	O	350	250	0,1	1000	1580	11	100	3800	1670	2850	7800
20	0,01	500	0,05	S	-	O	350	250	0,1	1000	1990	11	100	4200	1670	2850	8500
20	0,01	500	0,05	S	-	O	350	250	0,1	1000	1990	15	150	4200	1680	2850	9580
20	0,01	500	0,05	S	-	O	350	250	0,1	1000	1990	18,5	250	4250	1700	2850	10900
20	0,01	500	0,05	S	-	O	350	250	0,1	1000	1990	22	250	4250	1770	3000	12600
20	0,01	500	0,05	S	-	O	350	250	0,1	1000	1990	37	250	4300	1820	3330	17100
20	0,01	500	0,05	S	-	O	350	250	0,1	1000	2375	18,5	250	4950	1700	3000	11750
20	0,01	500	0,05	S	-	O	350	250	0,1	1000	2375	22	250	4950	1770	3000	14440
20	0,01	500	0,05	S	-	O	350	250	0,1	1000	2910	18,5	250	5250	1700	2850	12780
20	0,01	500	0,05	S	-	O	350	250	0,1	1000	2910	22	250	5250	1770	3000	14750
20	0,01	500	0,05	S	-	O	350	250	0,1	1000	2910	37	250	5300	1910	3330	20000
20	0,01	350	0,05	-	S	O	300	250	0,1	1000	2670	37	500	5750	2110	3640	27760
0	0,01	350	0,05	-	S	O	300	250	0,1	1000		45	500	5650	2250	3935	40500
20	0,01	350	0,05	-	S	O	300	250	0,1	1000	4400	22	250	7500	1770	3350	20800
20	0,01	350	0,05	-	S	O	300	250	0,1	1000	4400	37	250	7500	1910	3550	29000
20	0,01	350	0,05	-	S	O	300	250	0,1	1000	4400	37	500	7500	2110	3810	34600
0	0,01	350	0,05	-	S	O	300	250	0,1	1000	4400	45	500	7600	2650	3950	44000
0	0,01	300	0,05	-	S	O	250	250	0,1	1000	4400	55	750	8050	3200	4250	72000
0	0,01	300	0,05	-	S	O	250	250	0,1	1000	4400	55	750	8700	3200	4250	79500
0	0,01	300	0,05	-	S	O	250	250	0,1	1000	4400	55	1000	8800	3250	5900	95500
0	0,01	300	0,05	-	S	O	250	250	0,1	1000	4400	90	1250	8800	3250	6400	110000
0	0,01	300	0,05	-	S	O	250	250	0,1	1000		55	750	9800	3200	4250	85000
0	0,01	300	0,05	-	S	O	250	250	0,1	1000		55	750	10000	3250	5900	102000
0	0,01	300	0,05	-	S	O	250	250	0,1	1000		90	1250	10000	3250	6400	135000
0	0,01	300	0,05	-	-	O	250	250	0,1	1000		90	1250	10100	3500	6000	163000
0	0,01	300	0,05	-	-	S	250	250	0,1	1000		110	2000	10500	4350	7000	249000

S: Standart  
O: Opsiyon



# Special projects









**DURMA**



PANEL BENDER

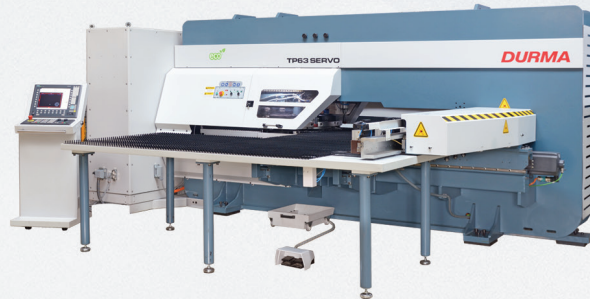

PUNCH

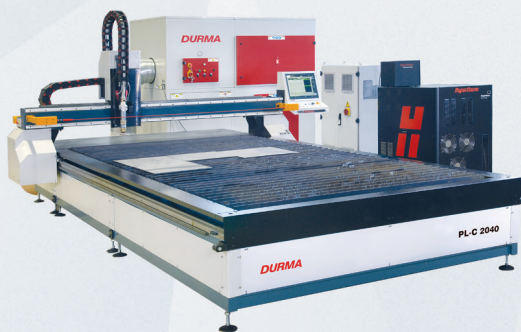

PLASMA



L ANGLE PROCESSING CENTER



IRON WORKER



POWER OPERATED SHEAR

**DURMA**



PRESS BRAKE



VARIABLE RAKE SHEAR



TUBE LASER CUTTING

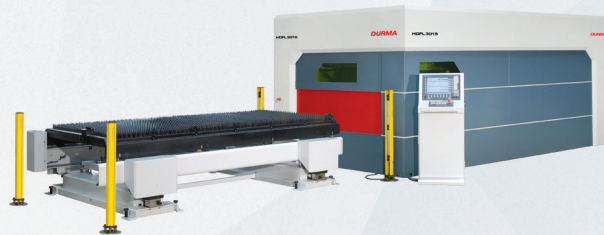

FIBER LASER

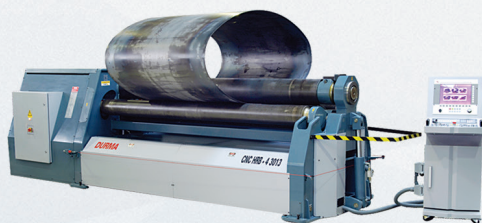

ROLL BENDING



PROFILE BENDING



CORNER NOTCHER

# DURMA

Today, Tomorrow, Forever...

V	b	r <sub>i</sub>	s(mm)																					
			0.5	0.8	1	1.2	1.5	1.8	2	2.5	3	3.5	4	4.5	5	6	7	8	9	10	12	15	18	20
6	5	1	2,5	6,5	10																			
8	6	1,3	2	5	8	11																		
10	7	1,7	1,5	4	6	9	13																	
12	9	2		3	5	7	11	16																
15	12	2,7			4	6	9	13	16															
20	15	3,3				4	7	10	12	19														
26	18	4,2					4	7,5	9	14	21													
30	22	5						6,5	8	12	19	24												
32	23	5,4							7,5	11,6	17	23	30											
37	25	5,8								10	14,5	20	26	33										
42	29	6,7									13	17	23	29	33,5									
45	32	7,5										16	21	27	33	48								
50	36	8,3											19	24	30	43	58							
60	43	10												20	25	36	49	64						
70	50	11,5													21	31	42	55	69					
80	57	13,5														27	37	48	60	75				
90	64	15															32	42	54	66	95			
100	71	17																38	48	60	86	134		
130	93	22																	37	46	66	103	149	
180	130	30																		33	48	75	107	153
200	145	33																			43	67	83	119
250	180	42																				54	77	92

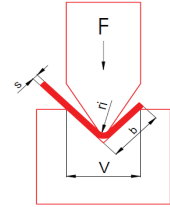

$$F = \frac{1,42 \times L \times Rm \times s^2}{1000 \times V} \text{ (Ton)}$$

F: Bending Force (Ton) L: Length (mm) Ri: Inside Radius (mm) Rm: Material Tensile Strength (daN/mm<sup>2</sup>) V: Channel Width (mm) B: Minimum Sheet Bending Side (mm) S: Thickness (mm)

## AD-S SERIES PRESS BRAKES

Durmazlar Makina San. ve Tic. A.Ş.  
OSB 75. Yıl Bulvarı Nilüfer-Bursa / Türkiye  
T: +90 224 219 18 00  
F: +90 224 242 75 80  
info@durmazlar.com.tr

www.durmazlar.com.tr



EN 2020/04/V09